

CORE SUN

SC25

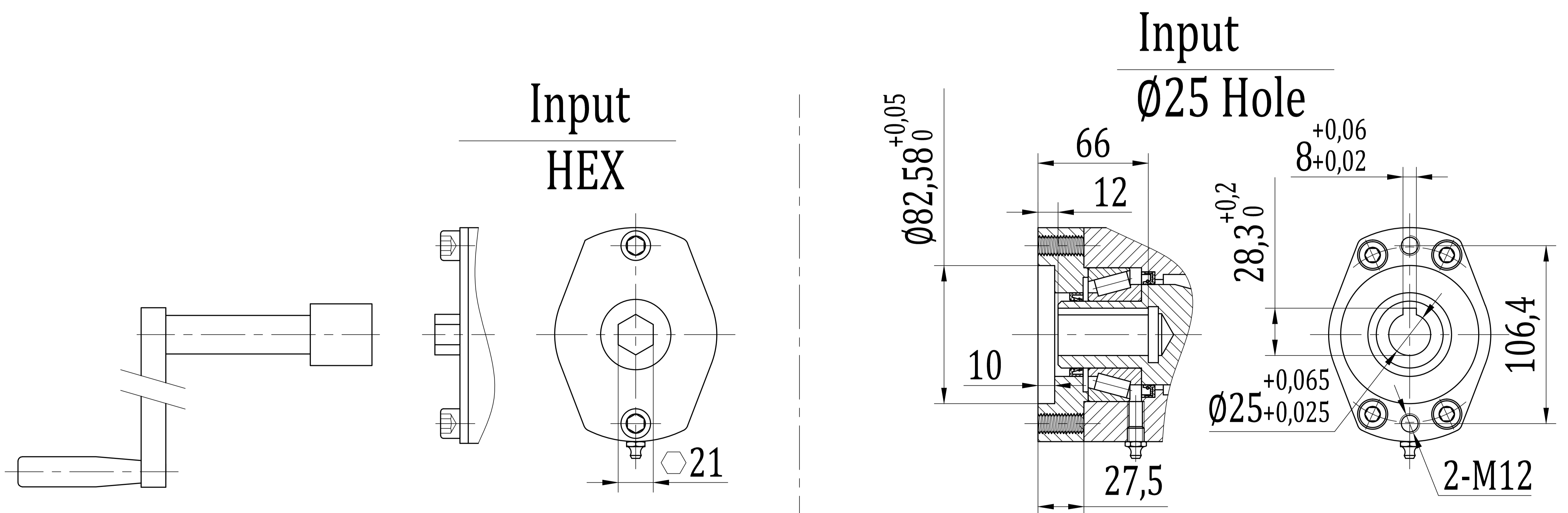
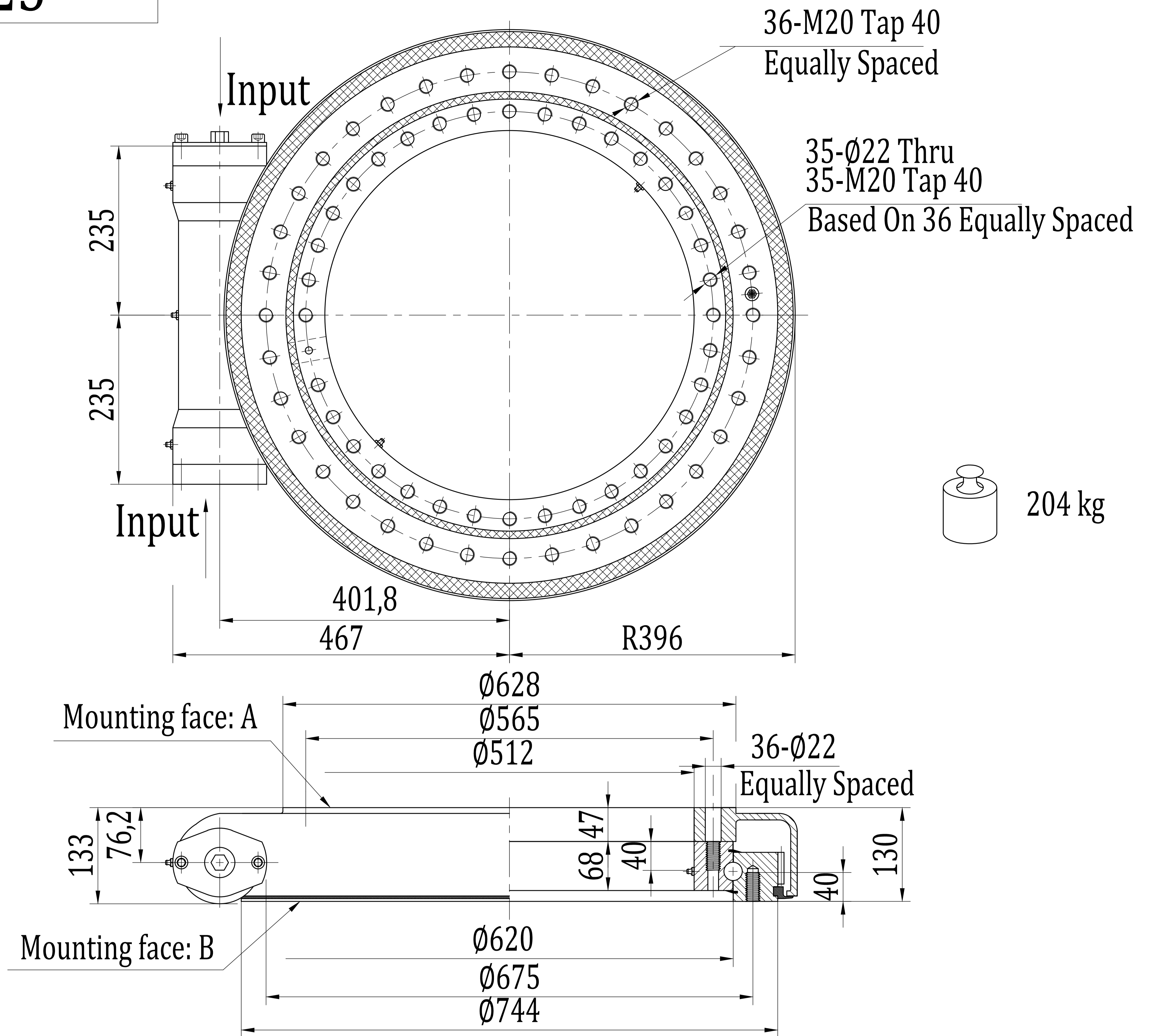

Slew Drive Performance Parameters

SC25	18 kN.m	271 kN.m	158,3 kN.m	2360 kN	945 kN	590 kN	470 kN	150 : 1	$\leq 0,15^\circ$ $C: \leq 0,09^\circ$ $B: \leq 0,06^\circ$ $A: \leq 0,03^\circ$	40%
	Output Torque	Tilting Moment Torque	Holding Torque	Static Axial Rating	Static Radial Rating	Dynamic Axial Rating	Dynamic Radial Rating	Gear Ratio	Precision	Efficiency